

THIEL

SmartSub[®]

SS2 Subwoofer

SW1 Subwoofer

Owner Information

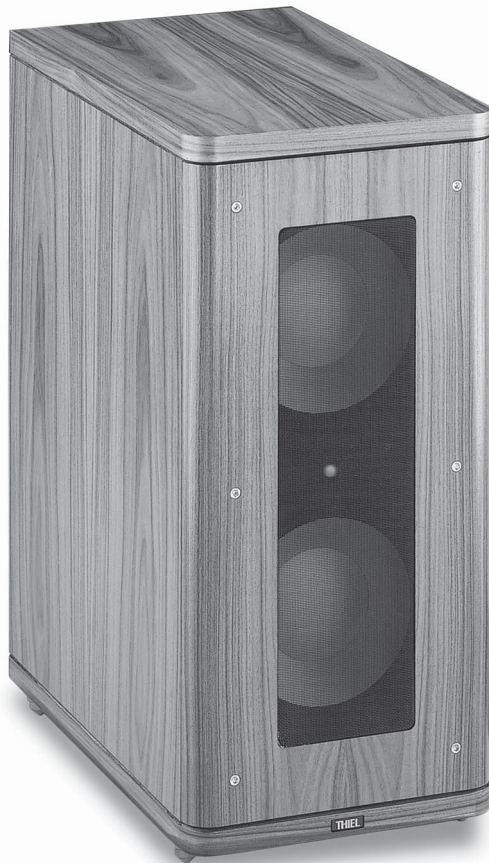

Thank you for purchasing the THIEL SS2 subwoofer system. It has been engineered to provide a very high level of performance and also incorporates innovative (patent pending) concepts in its design to solve the several special problems subwoofer systems usually exhibit. Consequently, it performs at a very high level with a wide variety of speakers and room locations.

You are welcome to contact our Customer Service department with any questions or for help in setting up this system. Our contact information is:

Tel: 859-254-9427 Fax: 859-254-0075 Email: service@thielaudio.com

Contents

Caution	3
Product Features	4
System Configurations	6
Crossover Use	8
Do you require a crossover?	8
Processor Bass Management	8
THIEL Passive Crossovers	8
THIEL SmartSub Integrator	8
Subwoofer Placement	9
Setting up the Subwoofer	10
Hookup	10
Setting the Surround Processor	10
Control Settings	10
Pilot light	10
Auto shutdown	10
Feet	11
Setup and Adjustment Flow Chart	12
Fuse Replacement	14
Specifications	14
Warranty	14

Caution

The SS2 has built-in electronics

- **Do not place the cabinet near sources of heat such as furnace registers or radiators.**
- **Do not allow water or other liquids into the unit.**
- **Allow some air circulation at the rear of the unit.**

Product Features

The SS2 is a very high performance, innovative subwoofer system that provides exceptionally deep, uniform, dynamic and low distortion bass reproduction. In addition, it will provide near-ideal performance with any room placement and when used with any type of main loudspeaker. These performance abilities are the result of new (patents pending) technology developed to overcome the major problems that subwoofers typically exhibit: poor integration with the main speakers and altered response due to nearby walls.

The SS2 can be used as a stand-alone unit, with a THIEL passive crossover or with the SmartSub Integrator, depending on your requirements. Here is a brief description of some of the unusual performance features this subwoofer system provides.

Very High Output, Very Low Distortion Woofers

The SS2 uses two very high output, very low distortion 10" drivers that utilize aluminum diaphragms, heavy cast chassis and THIEL's short coil/long gap, copper stabilized motor systems powered by 10 lb magnets in structures with a total weight of 20 lbs.

The short coil/long gap design results in very low distortion levels that are only one-tenth that of typical drivers with the same excursion rating. This magnet system's very long magnetic gap, along with the very high excursion suspension, allows each driver to move a very large amount of air (65 in³) – as much as many 15" woofers. By using two of these drivers the SS2 can effortlessly reproduce even demanding sources at high volume levels.



One of two SS2 drivers

1000 Watt Amplifier

The SS2 is powered by a Class D, switching-mode 1000 watt RMS amplifier.

The amplifier's very high power ensures that the woofers can provide all the output they are capable of without power compression or limiting.

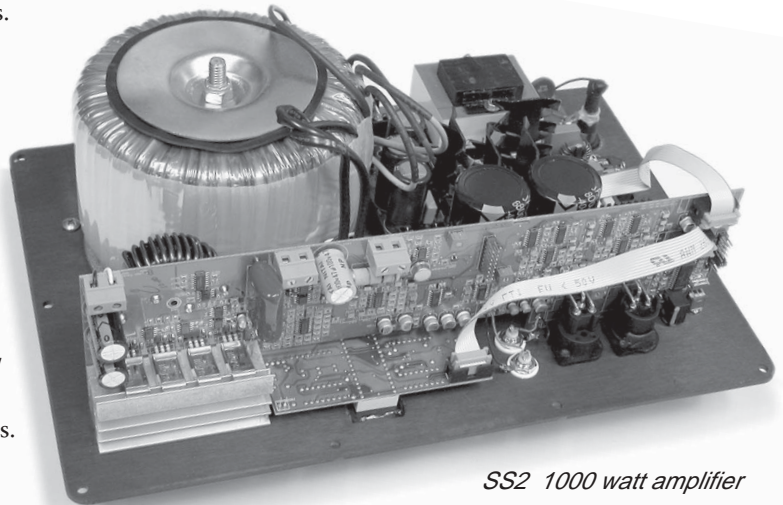

SS2 1000 watt amplifier

Since switching amplifiers are very high efficiency, about 92% in this case, very high power and currents can be delivered without large heat sinks, fans or additional power supply capacity for large amounts of waste heat. This type of amplifier is ideal for subwoofer applications since the amplifier does not have to deliver significant power at high frequencies.

Placement Correction

Placement controls (patent pending) on the SS2 match the unit's performance to its environment, whether away from walls, in a corner or anything in-between. These controls correct for both the general increase in level and for the partial cancellation of certain frequencies caused by a nearby wall. By providing correction of these effects for both the side and rear walls, the SS2 can provide accurately balanced, uniform response with virtually any room placement.



Temperature Correction

The SS2 electronics contains unique circuitry (patent pending) that corrects for compression distortion due to heating of the drivers' voice coils. Without this correction subwoofer output levels could decrease by as much as 5 dB and the response altered at times of high demand. The correction allows the subwoofer to provide more accurate, uncompressed and dynamic reproduction.



Heat sensor on voice coil

A thermistor is mounted to the woofer's voice coil so that the amplifier can continuously measure the voice coil's temperature. Knowing this, circuitry automatically adjusts both frequency response and level of the signal to accurately compensate for all effects of temperature on performance. This compensation ensures that the subwoofer's response and sensitivity don't change with temperature.

Protection from overheating

An automatic shutdown feature is included that protects the drivers from excessive heat produced by input levels that are excessively high. By knowing the temperature of the voice coil at all times, a shutdown is automatically executed if temperatures ever reach levels that could cause damage. The unit continues to monitor the temperature and is automatically restarted when the temperature falls to a safe level.

Accurate Matching to Main Speakers

Rather than providing generic built-in crossover controls that can rarely achieve high quality blending of the subwoofer with main speakers, the SmartSub can be used when needed with a separate unit, either a dedicated passive crossover or the universal SmartSub Integrator.

The passive crossovers provide perfectly blended augmentation of the main speakers, allowing the combination to provide very accurate reproduction of the entire sonic spectrum, to below the audible range.



Passive Crossover

The SmartSub Integrator provides unprecedented ability to perfectly match any main speakers and provide total system performance that is as well integrated and balanced as a full range speaker. This superior performance is achieved by innovative circuitry (patents pending) that automatically calculates the ideal subwoofer response to perfectly match the characteristics of the main speakers. Therefore, instead of the usual crossover controls that tell the subwoofer how to perform, the SmartSub Integrator has settings for the characteristics of the main speakers you are matching, the configuration of your system and the performance you desire. This information is then used to automatically calculate and implement the ideal subwoofer response. In addition, the unit enables the total system to operate in either augment or crossover system mode and can control up to 16 subwoofer units in either mono or stereo configuration.



SmartSub Integrator

System Configurations

The SS2 can be used in four ways depending on your requirements:

1. As a stand-alone unit.
2. With a passive crossover.
3. With the SmartSub Integrator in augment mode.
4. With the SmartSub Integrator in crossover mode.

The configuration chosen will determine your required equipment, hookup connections and processor settings. Which system configuration is best for you depends mainly on the capabilities of your main left/right speakers.

Additional discussion of these options can be found in the section *Crossover Use*. In addition, there is a comprehensive flow chart for your reference on pages 12 and 13 that guides you through all aspects of system configuration, hookup, and adjustment. More information on Integrator hookup and adjustment can be found in that product's manual.

If your main speakers play sufficiently loudly for all your uses *and* they reproduce the bass with satisfying completeness, then the subwoofer is only needed to reproduce the LFE (low frequency effects, or subwoofer) channel and it can be used in the LFE configuration without a crossover or Integrator.

LFE Configuration

In this configuration the subwoofer is used only for reproduction of the 'point one' subwoofer channel and is driven by the processor's subwoofer output connected to the subwoofer's LFE input.

This configuration is a good choice when the main speakers play sufficiently loud and their bass is satisfactory for applications other than movie effects.

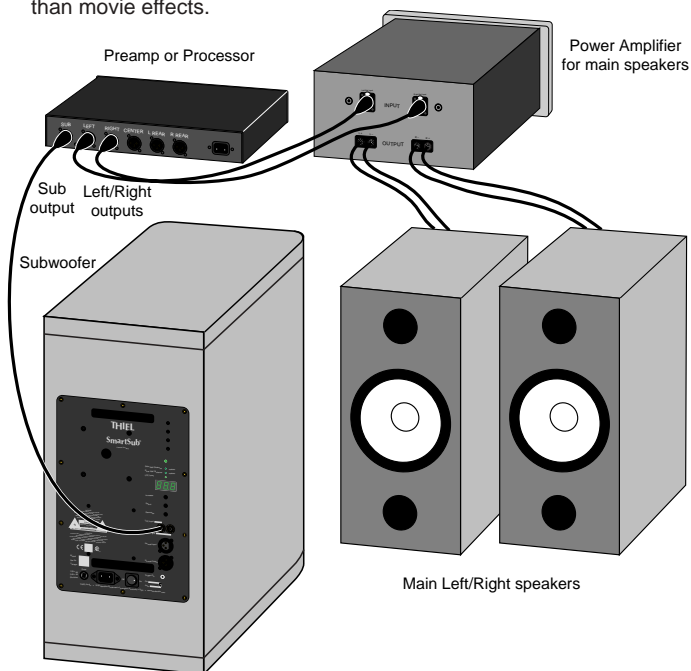

If your main speakers play sufficiently loudly for all your uses but do not reproduce the full low frequency range of the left/right channels, you should also use the subwoofer to augment the bass response of your main speakers. This can be accomplished without altering the signal or wiring to your main speakers by using one of the next two configurations.

2 A SmartSub Passive crossover can be used if one is available to match your main THIEL speakers and low frequency adjustments are not required.

Passive Crossover Configuration

This configuration has connections and benefits identical to the following one except the passive crossover provides no adjustments and is available for only selected THIEL model main speakers.

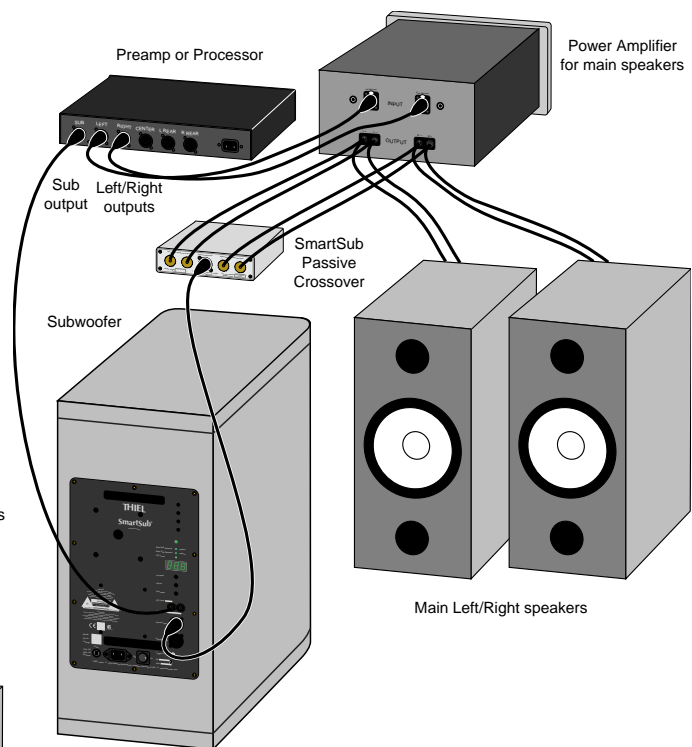

3 The SmartSub Integrator in augment configuration should be used if a passive crossover is not available for your main speakers, you desire adjustability of the main channel bass level or extension, or if you desire more than one subwoofer in your system, or two stereo subwoofers.

Integrator Augment Configuration

In this configuration the subwoofer is used to reproduce both the subwoofer channel and the deep bass portion of the left and right channels and achieves near-perfect blending of the main channel bass with the main speakers.

Tell the processor the main speakers are large, even if they are not.

This configuration can be ideal if the main speakers play loudly enough. It's also perfect for audio systems where the subwoofer is used to extend the bass range.

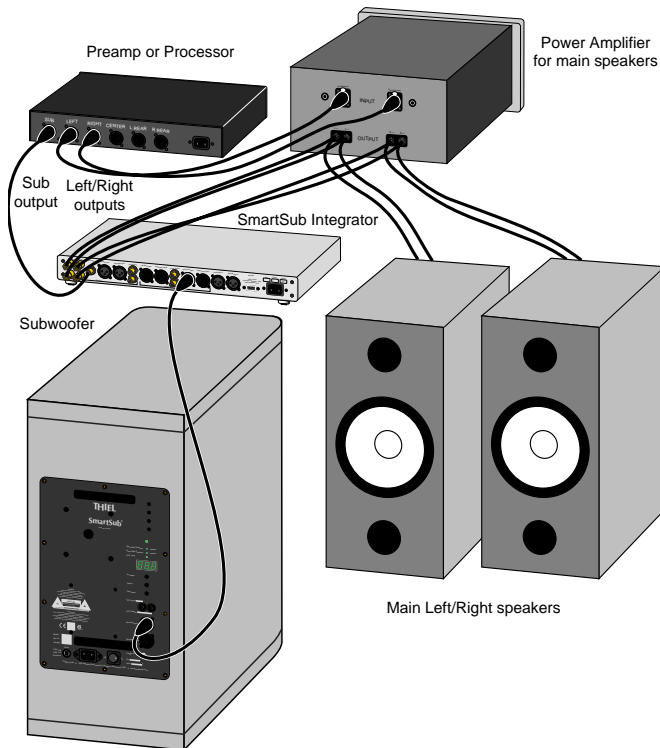

4 If your main speakers do not play sufficiently loudly due to bass overloading, then the Integrator should be used in crossover mode to allow the transfer of low frequency energy from the main speakers and into the subwoofer.

Integrator Crossover Configuration

Connecting the SmartSub Integrator between the processor and the main speaker power amp allows the Integrator to be used in crossover mode so that bass can be kept from the main speakers and reproduced by the subwoofer instead. This usually allows the main speakers to play more loudly than otherwise so that the bass range *and* the output of the system are enhanced.

Tell the processor the main speakers are large, even if they are not.

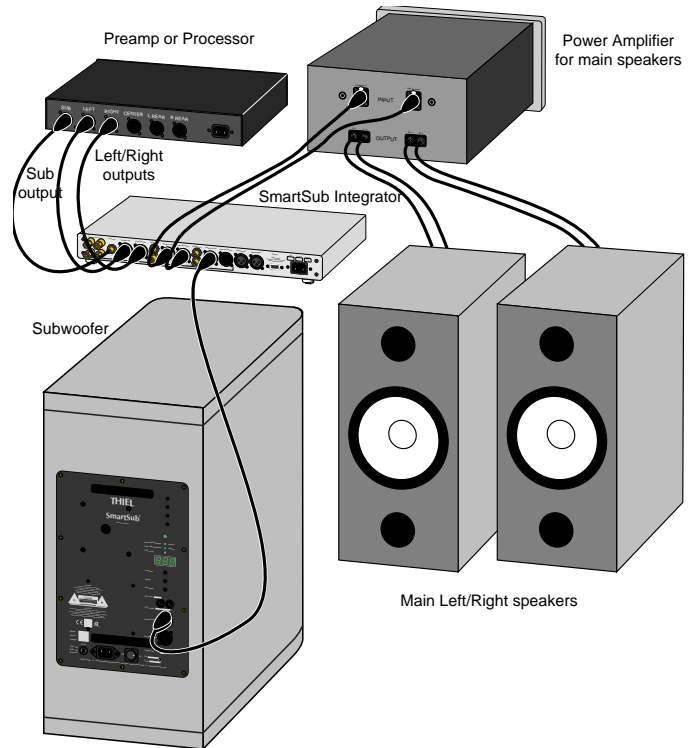

Crossover Use

Do you require a crossover?

Without a crossover the subwoofer will provide very high quality reproduction of the Low Frequency Effects (LFE), or “point 1”, channel of a multi channel sound system.

When used with a crossover, the subwoofer can, in addition, also reproduce the low frequency part of the left and right channels in a 2 channel or multi channel music or video sound system. It is desirable to use the subwoofer in this capacity if the main speakers do not reproduce the entire bass range or if the main speakers cannot play at the volume level desired without distortion. Depending on your requirements, the crossover can be either the bass management capabilities of a sound processor, one of our dedicated passive crossovers, or the SmartSub Integrator. Here is a description of each of these with their advantages.

Crossover Types Compared

<u>Crossover type</u>	<u>Integration</u>	<u>Flexibility</u>	<u>XO mode?</u>
Processor	Poor	Low	Yes
Passive XO	Very good	Low	No
Integrator	Excellent	High	Yes

Processor Bass Management

Surround sound processors have the ability to redirect the bass energy away from your main speakers and into the subwoofer channel where it is reproduced by the subwoofer, with the benefits of allowing the main speakers to play louder than they otherwise would, and the bass to be reproduced better. This is implemented by telling the processor that your main speakers are “small”.

The limitation of this bass management approach is the poor balance and integration between the subwoofer and the main speakers that the processor’s generic filters provide. It may be suitable for low standard video systems and will seldom be suitable for music.

THIEL Passive Crossovers

There are several passive crossovers available that match a THIEL subwoofer to various THIEL speaker models. Since they are designed for specific models, they achieve very good integration and balance between the subwoofer and the main speakers. Also, being passive, they are of quite reasonable cost. They allow the subwoofer to *augment* the main speakers in the precise way that will enable the combination of main speaker and subwoofer to produce perfectly balanced and blended sound with the bass range extended to below 20 Hz. Two passive crossovers can be used with two subwoofers to provide stereo bass reproduction.

A limitation is that these crossovers do not redirect bass energy away from the main speakers and so the main speakers will not play any louder than otherwise.

This is often an ideal system for music systems and a good approach for video systems when the main speakers play sufficiently loud but do not have extended, deep bass response.

THIEL SmartSub Integrator

The SmartSub Integrator provides a high level of flexibility, universality, and functionality. It provides near-perfect integration with any main speakers, regardless of brand. It can be used both in *augment* mode, where the subwoofer extends the bass range of the main speakers, and in *crossover* mode. In crossover mode the built-in high pass filter transfers bass energy away from the main speakers and redirects it to the subwoofer, so that the main speakers are able to play louder. The Integrator also allows adjustment of crossover frequency, LFE level and separate adjustment of main channel bass extension and low frequency level. In addition, it can control stereo subwoofers, and be used to control systems with up to 16 subwoofers.

This is a complete, no-compromise approach with no limitations.

Subwoofer Placement

Caution! The subwoofer has built-in electronics.

- **Do not place the cabinet near sources of heat such as furnace registers or radiators.**
- **Do not allow water or other liquids into the unit.**
- **Allow some air circulation at the rear of the unit.**

If the subwoofer is used only for LFE reproduction, it can be placed almost anywhere. If more than one subwoofer is used, placing them in different locations tends to even out possible room resonance irregularities.

If the subwoofer is used with a crossover or Integrator to reproduce the low frequency portion of the main channels then placement is a little more important. The subwoofer(s) preferably should be approximately the same distance from the main listening area as the main speakers. With one subwoofer the best position is usually somewhere between the main speakers but behind them a few feet if possible in order to maintain good stereo imaging.

The use of two subwoofers allows the low frequency signal to be processed in stereo by the crossover unit, and therefore to provide the best possible imaging. In this case, it is preferable that the subwoofers be placed somewhat near each main speaker, near each speaker, or at the side walls.

Higher output is achieved when the subwoofer is placed near a wall and even more output is available when placed near a corner of the room. If very high output is desired in large rooms corner placement can be used with little trade-off in sound quality. For use in very large rooms, greater than 4,000 ft³, more than one SS2 may be required if very high playback levels are desired.

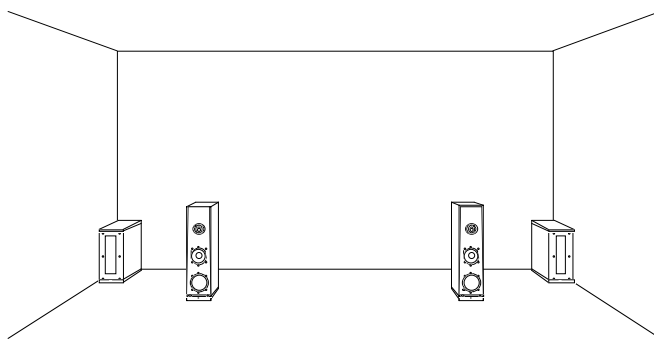

Dual corner placement provides maximum output from each sub, higher total output, good "imaging" and more even room response.

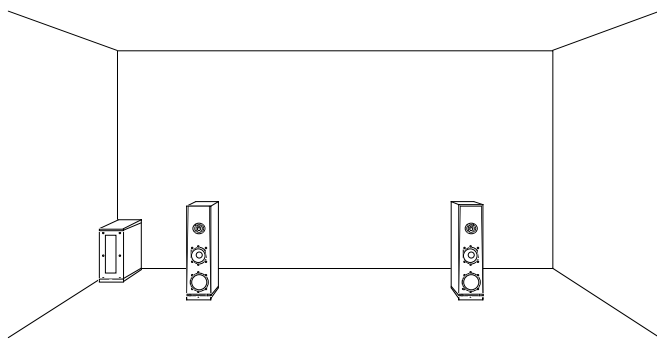

For LFE ("point 1") channel use, corner placement is often ideal, providing maximum output.

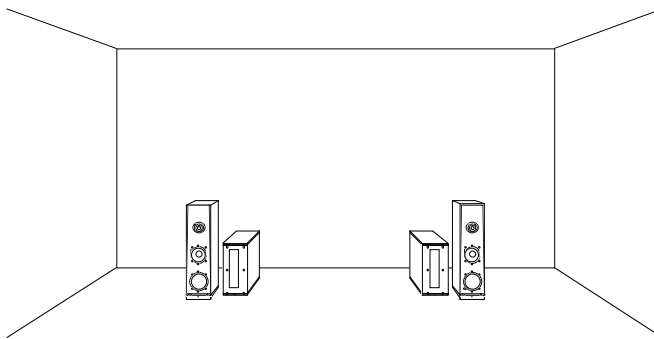

Dual subs near the main speakers provide the higher output of dual subs combined with the best "imaging" and most even room response.

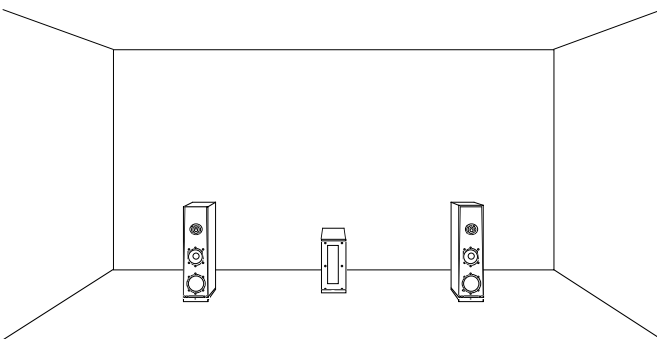

Center placement against the front wall is often optimum for music or movie systems where the subwoofer is used to reproduce left/right channel bass. It provides high output and good "imaging".

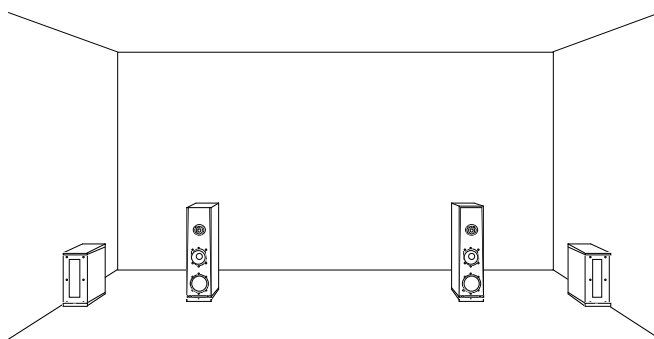

Dual subs at the side walls provide the higher output of dual subs, high output from each sub, good "imaging" and even room response.

Setting up the Subwoofer

Hookup

If the subwoofer is being used with a passive crossover or SmartSub Integrator, a balanced XLR interconnect cable is connected from the unit's subwoofer output to the subwoofer's *Normal Input*. If more than one subwoofer is used, they are "daisy-chained" by connecting an additional XLR interconnect cable from the *Normal Output* connector of the first subwoofer to the *Normal Input* of the next subwoofer.

If the Integrator is not being used, then an RCA interconnect cable is connected from the processor's subwoofer output jack to the subwoofer's *LFE Input*. If more than one subwoofer is used, an additional cable is connected from the *LFE Output* connector of the first subwoofer to the *LFE Input* of the next subwoofer.

The subwoofer's power cord must be plugged into an AC outlet and the power switch turned to the "on" position.

Setting the Surround Processor

Tell the processor that you have a subwoofer.

If you are using a Passive Crossover or the Integrator then the surround processor should be set to deliver the left/right channel bass to the main speaker channels by telling it that the main speakers are full-range (even if they are not).

If you are not using a Passive Crossover or Integrator and the main speakers are not able to reproduce deep bass, you can tell the processor that the front speakers are "small" so that the main channel bass is redirected to the subwoofer.

If you are using the Integrator set the subwoofer channel level in the processor to the same level as the left and right channels and use the Integrator to adjust the LFE level. If you are not using the Integrator use the processor's subwoofer level setting to adjust the LFE level.

Control Settings

There are three adjustments which are made by using the three buttons below the numeric readout. Use the Select button to select which adjustment will be active, indicated by which light is lighted. The setting of the active adjustment is displayed in the readout for 10 seconds after any of the buttons is pressed. Adjust the active setting by using the Increase and Decrease buttons.

The *LFE Level* is functional only for the LFE input. **If you are not using the LFE input, set this to minimum (OFF).** If you are using the LFE input then the subwoofer level must be adjusted to achieve the proper balance with the other speakers. It is usually more convenient to adjust the subwoofer level with the processor's subwoofer level control, and in this case a good starting point for the level setting is 90. If the system's processor cannot control subwoofer level, then the subwoofer's level adjustment is used. The level can be adjusted "by ear" to achieve a pleasing balance so that the low frequency sound effects are not too weak or too strong.

Unfortunately, an SPL meter cannot be used to accurately adjust subwoofer level due to differences in bandwidth between the subwoofer and the main speakers.

The placement settings should be adjusted to correspond to the placement of the subwoofer. Set the *Side Wall Distance* to the distance from the side of the subwoofer to the side wall and the *Rear Wall Distance* to the distance from the rear of the subwoofer to the rear wall. The distance is displayed in meters, which is the distance in feet divided by 3.3. If a distance is greater than 2.5 meters (or 8 feet) set the control to maximum (OFF). If the subwoofer is placed in a cabinet the settings should correspond to the room wall distances, not the distances to internal cabinet walls. If the subwoofer is recessed into the wall so the front is flush with the wall, then the rear control should be set to -0.5.

If the norm/auto switch is turned to the "On" position the subwoofer is always on, ready to reproduce a signal. If the switch is set to the "Auto" position, the subwoofer's amplifier will automatically turn on when it detects a signal to reproduce and stay on for approximately 1/2 hour after a signal.

The unit is equipped with a control input that will turn the unit on when a DC voltage between 5 and 25 volts is applied, if the Auto/On switch is set to the "Auto" position.

Pilot light

The pilot light on the back panel and the front of the subwoofer glows green during normal operation. This green light can be turned off if you desire by pressing both the increase and decrease buttons simultaneously when the numeric display is not on. The light can be turned back on in the same way.

Auto shutdown

The subwoofer is equipped with an automatic shutdown feature that will turn off the output of the subwoofer if the drivers, amplifier or rear panel get too hot or if the line voltage is too low. This can occur if a very high input level lasts too long or if the subwoofer has insufficient ventilation. If the automatic shutdown is activated, subwoofer output will be interrupted and the light on the input panel will flash. The unit will resume operation when conditions return to safe levels. Here is a list of the light flash modes and the conditions they indicate.

Green / Red	Hot drivers
Red long / Green short	Hot rear panel
Red / Yellow	Hot amplifier
Yellow blinking	Low line voltage

If the unit shuts down often, this indicates that you should improve its ventilation, turn down the system's volume control, turn down the subwoofer's level control or add an additional subwoofer.

Feet

The subwoofer is supplied with four pointed, screw-in feet that can be used to provide firmer coupling to the floor for slightly better sound quality and to prevent the unit from moving during use. Please be advised that their use can put

dents in hardwood floors. They are screwed into the bottom of the unit, and should be individually adjusted until the unit is firmly seated onto the floor without rocking. Then tighten each of the back-nuts to lock the feet in place.

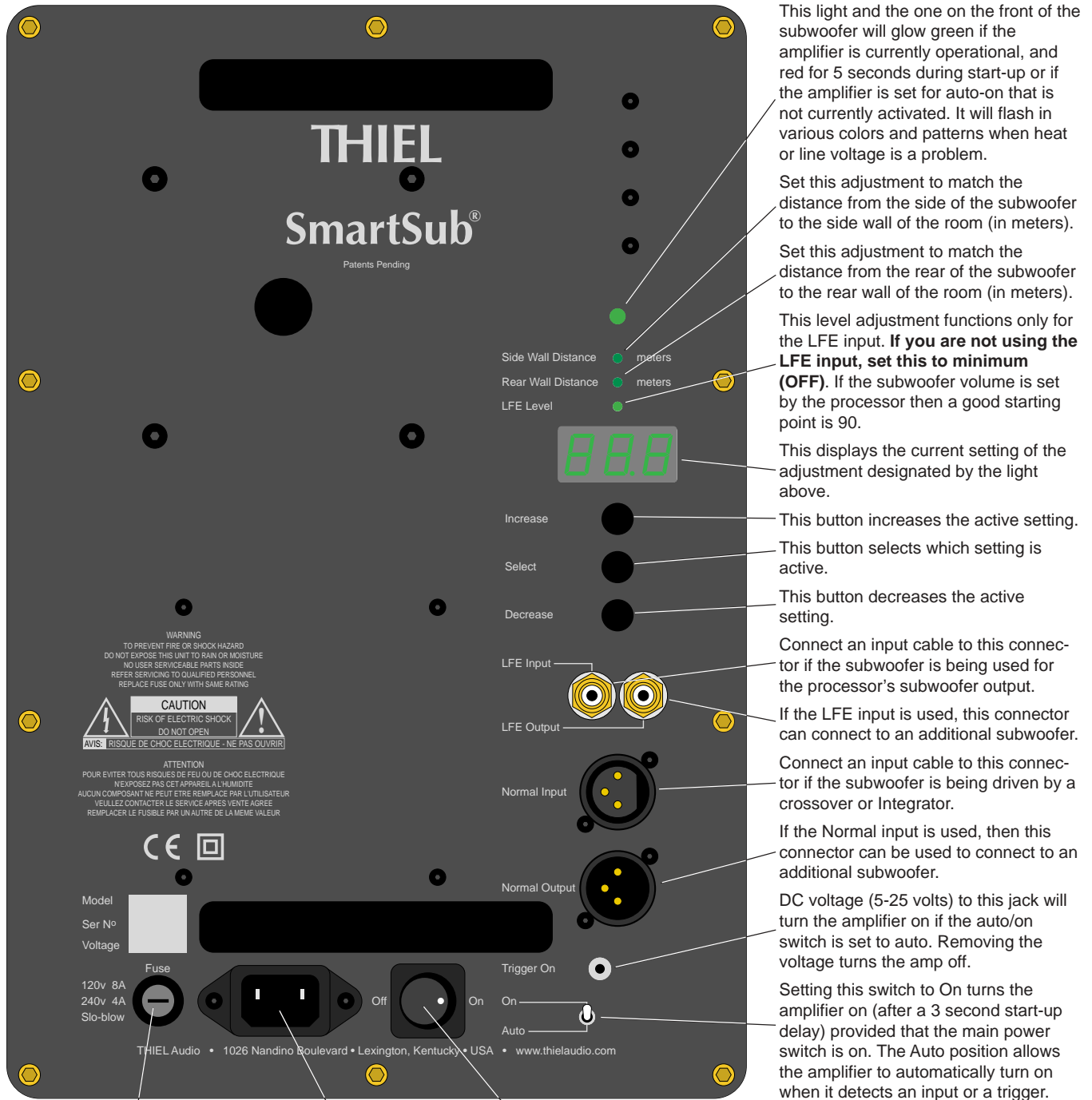

This light and the one on the front of the subwoofer will glow green if the amplifier is currently operational, and red for 5 seconds during start-up or if the amplifier is set for auto-on that is not currently activated. It will flash in various colors and patterns when heat or line voltage is a problem.

Set this adjustment to match the distance from the side of the subwoofer to the side wall of the room (in meters).

Set this adjustment to match the distance from the rear of the subwoofer to the rear wall of the room (in meters).

This level adjustment functions only for the LFE input. **If you are not using the LFE input, set this to minimum (OFF).** If the subwoofer volume is set by the processor then a good starting point is 90.

This displays the current setting of the adjustment designated by the light above.

This button increases the active setting.

This button selects which setting is active.

This button decreases the active setting.

Connect an input cable to this connector if the subwoofer is being used for the processor's subwoofer output.

If the LFE input is used, this connector can connect to an additional subwoofer.

Connect an input cable to this connector if the subwoofer is being driven by a crossover or Integrator.

If the Normal input is used, then this connector can be used to connect to an additional subwoofer.

DC voltage (5-25 volts) to this jack will turn the amplifier on if the auto/on switch is set to auto. Removing the voltage turns the amp off.

Setting this switch to On turns the amplifier on (after a 3 second start-up delay) provided that the main power switch is on. The Auto position allows the amplifier to automatically turn on when it detects an input or a trigger.

See page 14 for fuse replacement Power cord plugs here Turn power on here

Setup and Adjustment Flow Chart

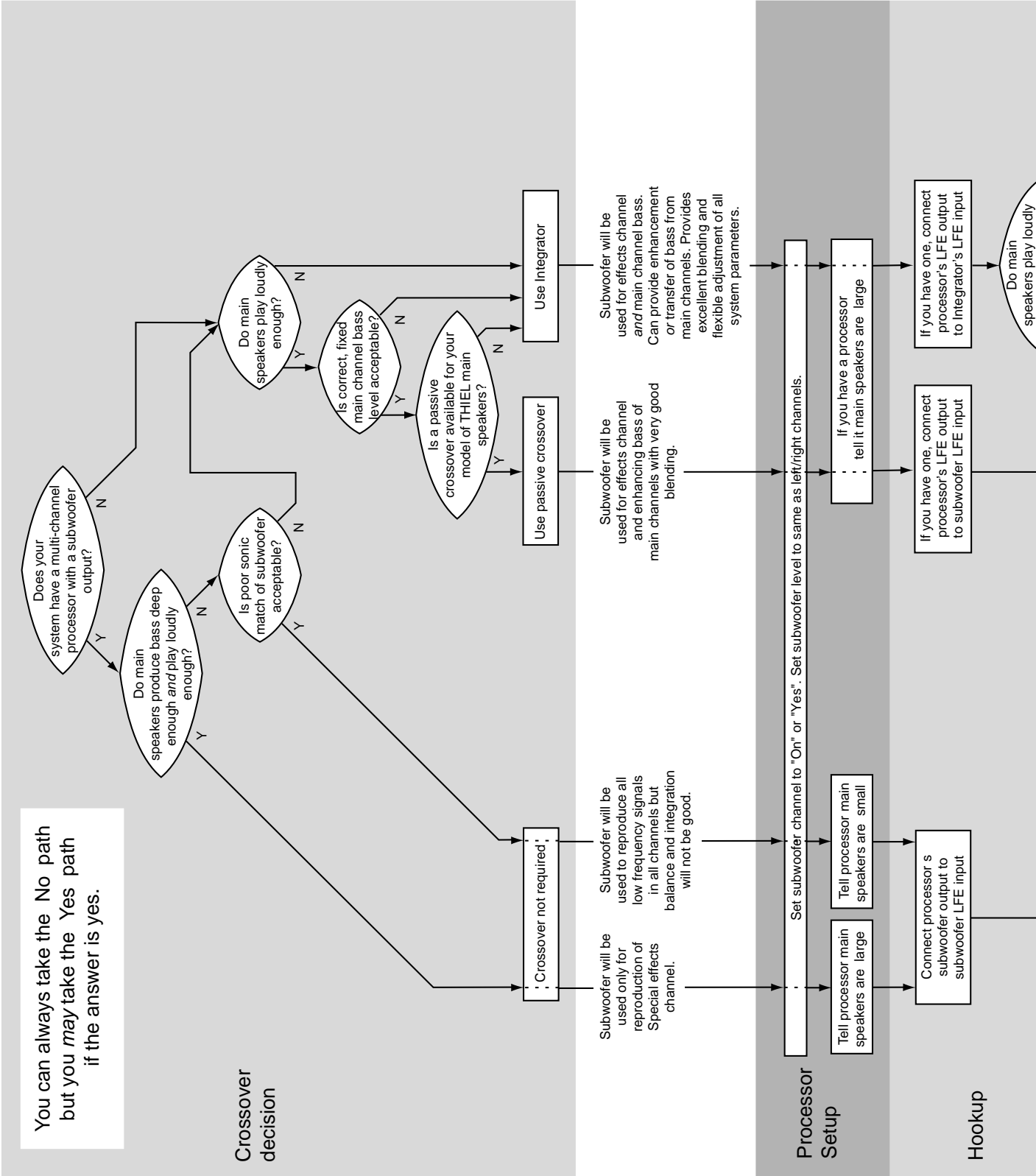

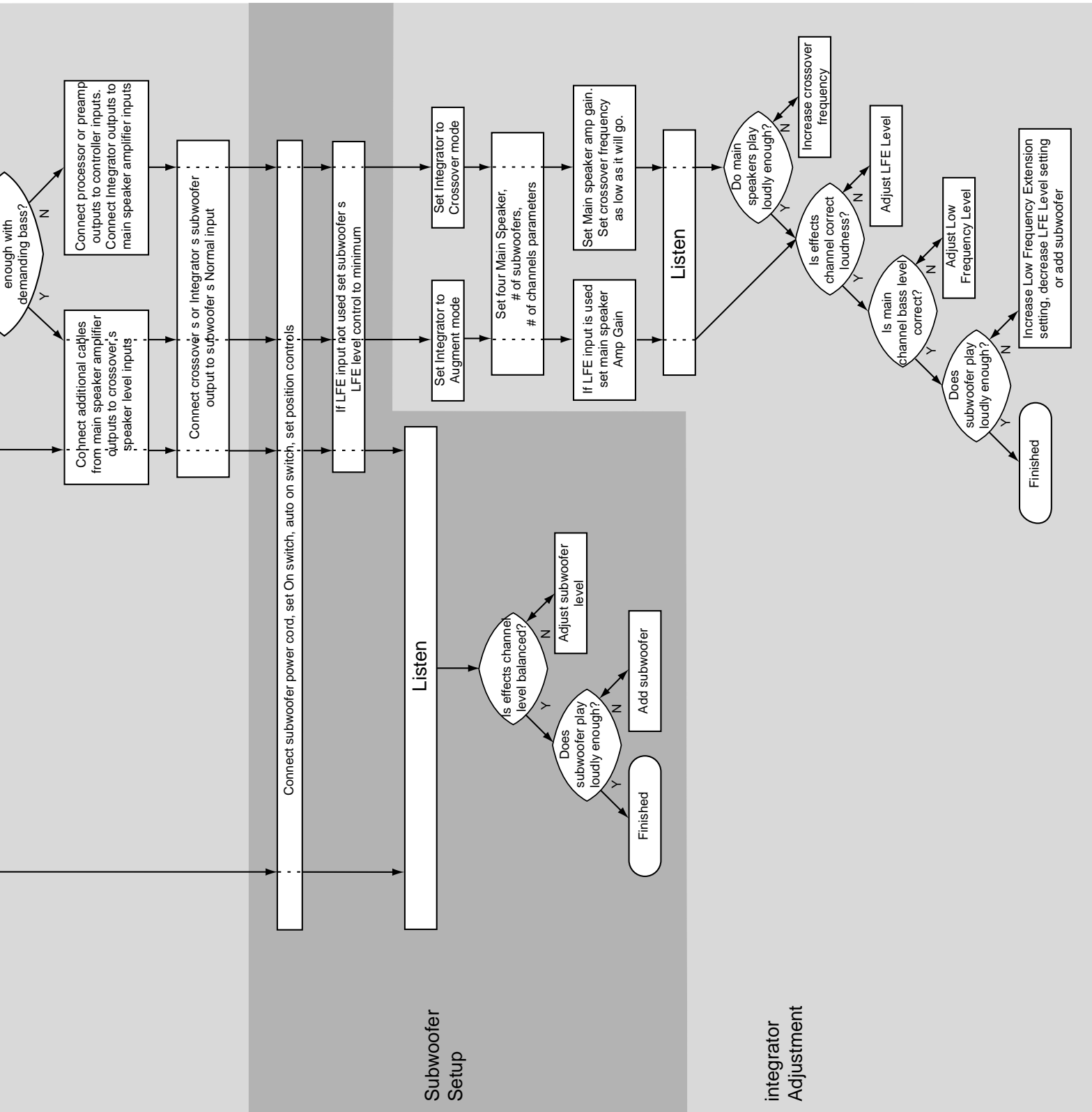

Fuse Replacement

If the subwoofer is completely dead, with no indicator lights on, the main fuse has probably blown and will need to be replaced. The fuse should be replaced only with an equivalent type. The fuse type is 5 x 20 mm size, slo-blow or time delay type, with a rating of 4 amp for 230 volt units and 8 amp for 115 volt units. The BUSS number is GMC-4A or GMC-8A, respectively. Littlefuse numbers are 232004 or 218008. Or contact THIEL for a replacement fuse.

Specifications

Subwoofer cabinet	Response Normal input: 12 Hz–300 Hz, ±0.5 dB; LFE input 17 Hz–300 Hz, ±0.5 dB Bandwidth Normal input 10-800 Hz, ±3 dB; LFE input: 16–800 Hz, ±3 dB Size 11" wide, 20" deep, 23½" high, plus 1½" clearance at rear Weight 108 lbs Driver description Two, 10" with 20 lb magnet structure, 2.5" voice coil, aluminum diaphragm Driver output ±16 mm linear excursion, 130 in ³ linear displacement Acoustic output depending on placement, up to 105 dB @ 20 Hz or 112 dB @ 30 Hz Sensitivity 1 volt for 120 dB @ 1 m
Amplifier	Type Switching, Class D Power output (at 120 or 240 line voltage) 1000 watts, RMS Line voltage 90-130 or 180-260

Warranty

THIEL warrants every THIEL model SS2 system against defects in materials and workmanship to the original owner for a period of ten years from the date of purchase. THIEL will, at no charge, replace any defective part and make any repairs necessary to ensure its proper performance when the defective unit is returned to us postpaid.

This warranty does not cover damage due to accident or abuse and is void if the unit has been tampered with.

This warranty is automatic and no registration is required. This warranty gives you specific legal rights. You may also have other rights which are particular to your state.

THIEL

1026 Nandino Blvd., Lexington, KY 40511, USA

www.thielaudio.com